

Assembly instructions
Montageanweisung
Instructions de montage
Montážní návod
Montážni návod
Montagevejledning
Instrucciones de montaje
Szerelési utasítás
Istruzioni di montaggio
Montasjeveiledning
Montage instructie
Instruções de montagem
Instrukcja montażu
Montageanvisning
Asennusohjeet
Montaj talimatı
Instruțiuni de montaj
Инструкция по монтажу
οδηγία συναρμολόγησης
安装说明书
تعليمات التركيب



Danger
Lebensgefahr
Danger de mort
Nebezpečí
Nebezpečenstvo
Fare
Peligro
Életveszély
Pericolo di morte
Fare
Levensgevaar
Perigo
Niebezpieczeństwo
Varning
Vaara
Hayati Tehlike
Pericol
Опасность
κίνδυνος θανάτου
危險
خطر على الحياة



Installation by electricians only
Montage nur durch Elektrofachkräfte
Montage uniquement par un électricien
Montáž pouze osobami s elektrotechnickou kvalifikací
Montáž iba osobami s elektrotechnickou kvalifikáciou
Må kun installeres af en aut. el-installatør
Debe ser instalado por un profesional eléctrico
Csak szakképzett személy szerelheti
Montaggio esclusivamente ad opera di personale specializzato
Må monteres av autorisert installatør
Montage alleen door elektromonteurs
Deve ser instalado por um profissional
Montaż tylko przez uprawnionych instalatorów
Får endast utföras av behörig elektriker
Asennus vain sähköasentajan toimesta
Sadece uzman kişiler monte edebilir
Instalare numai de către electricieni
Монтаж может производить только элекрик
Εγκατάσταση μόνο από ηλεκτρολόγους
仅允许合格电气技师进行安装
التركيب فقط من قبل عمال كهرباء الاختصاصيين

CHVZ-01/04

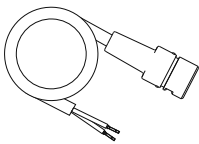
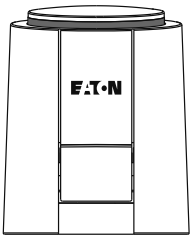

CMMZ-00/17

Danfoss RA

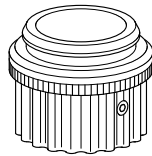

CMMZ-00/18

Beulco (ab 2006),
SBK (ab 1998),
Cazzaniga, Dumser,
Heimeier, Honeywell,
IOVAR,
MNG (ab 1998),
ONDA, Ovendrop,
Reich (Verteiler),
Schlösser, Siemens,
Taco

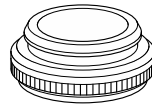

CMMZ-00/38

Tour & Andersson,
Nereus Type 9440
(Angle valve)

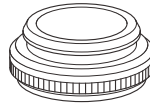

230VAC/1W/50Hz

	T=-25°C - +60°C
	T=0°C - +100°C

IP54

100N ± 5%

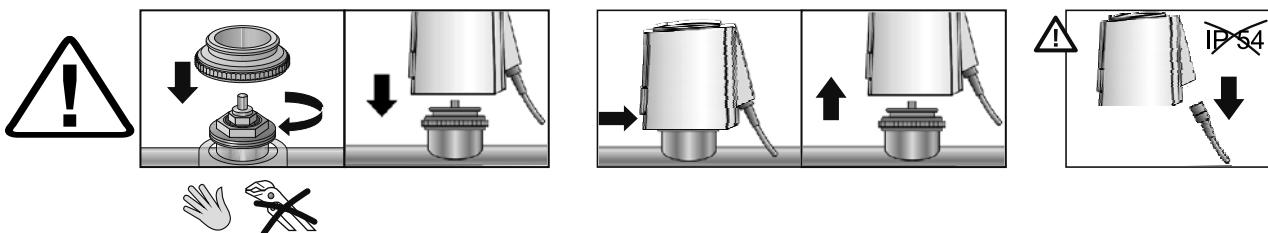
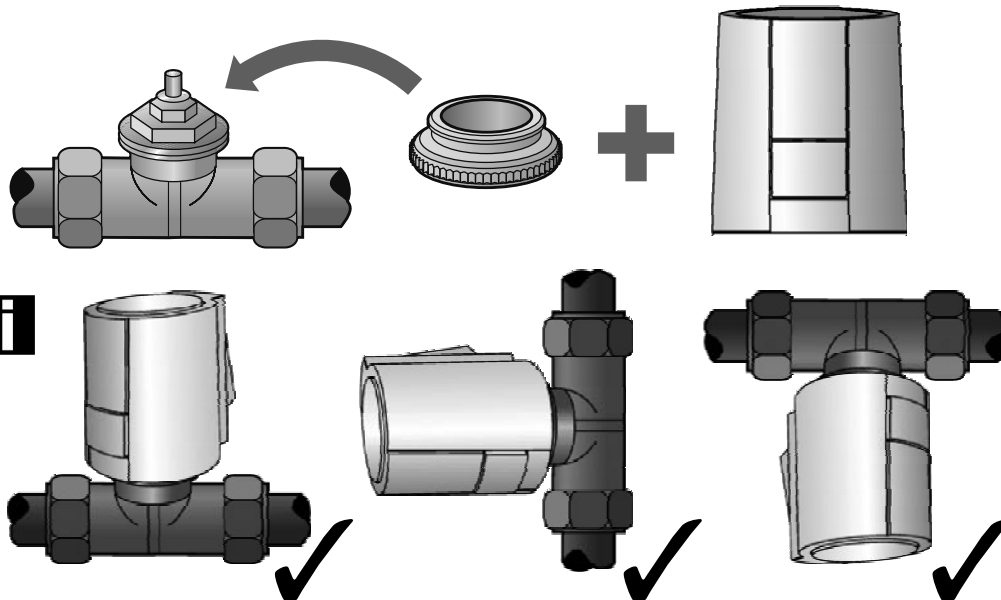

1.x

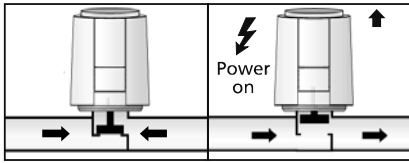
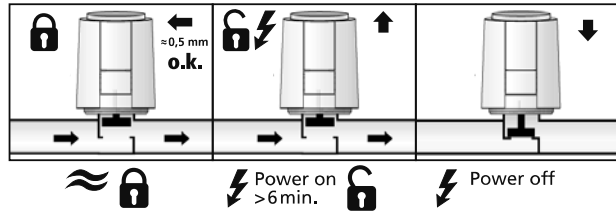
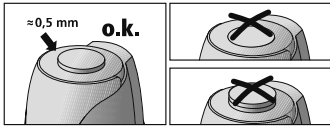

	0,75 mm ²
	10 mm

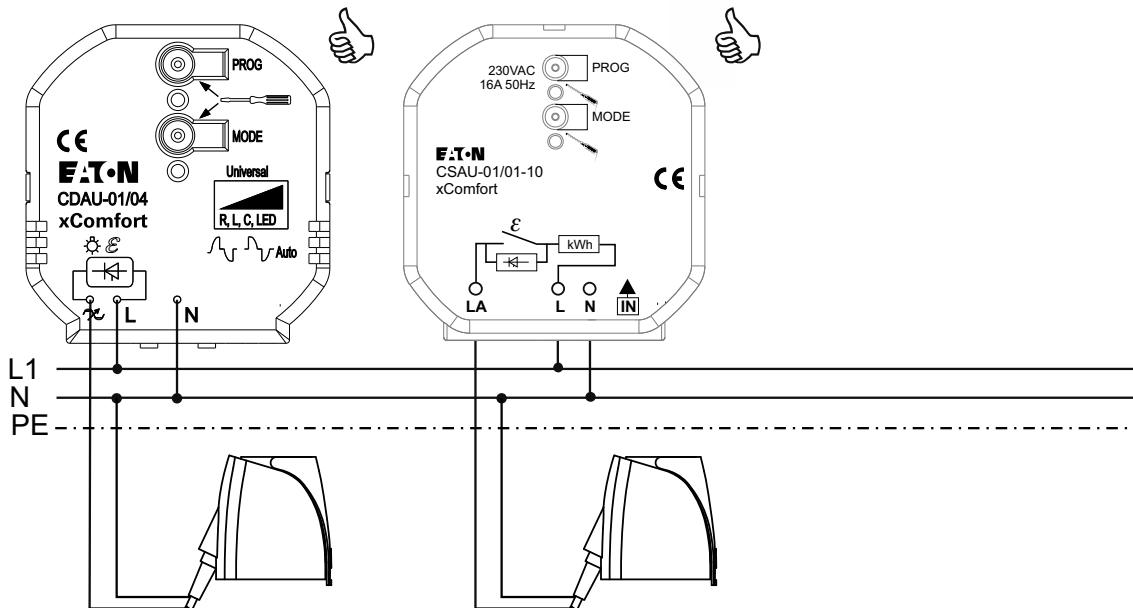
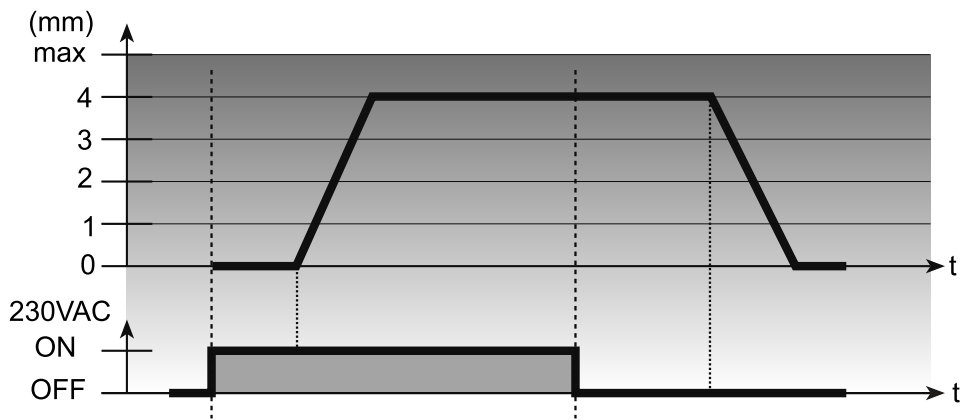
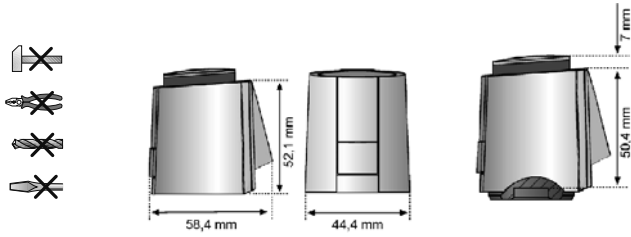



Declaration of Conformity

We, EATON Industries (Austria) GmbH
 3943 Schrems, Eugenia 1
 Austria

declare under our sole responsibility that the product (family)

Eaton - Valve-Drive NC

CHVZ-01/04

(the declaration of conformity applies to all listed types within our actual product catalogue)

provided that it is installed, maintained and used in the application intended for, with respect to the relevant manufacturer's instructions, installation standards and "good engineering practices"

complies with the provisions of Council directive(s):

Low Voltage Directive 2014/35/EU

EMC Directive 2014/30/EU

RoHS Directive 2011/65/EU

based on compliance with following standard(s):

EN 60730-2-14:1997 + A1:2001 + A2:2008 + A11:2005 + A2:2008,
 EN 60730-1:2016, EN 50419:2006, EN 50581:2012







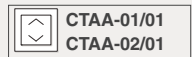

 Fernando Ceccarelli
 Senior Vice President
 General Manager

17.11.2017

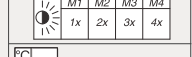
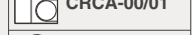
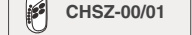
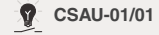
 Friedrich Schröder
 Director Quality
 & Systems

Affixing date of CE mark: 2015
 Doc.Id.: CHVZ-0104_171117

	
<h2>RF- SYSTEM</h2> <h3>BASIC - MODE - CARD</h3>	
 <p>CTAA-01/01 CTAA-02/01</p>  <p>CBEU-02/01 CBEU-02/02</p>  <p>M1 M2 M3 M4 1x 2x 3x 4x</p>  <p>CRCA-00/01</p>  <p>CHSZ-00/01</p>	 <p>CSAU-01/01</p>  <p>CJAU-01/01</p>  <p>CDAU-01/01</p>
