

Assembly instructions  
Montageanweisung  
Instructions de montage  
Montážní návod  
Montážni návod  
Montagevejledning  
Instrucciones de montaje  
Szerelési utasítás  
Istruzioni di montaggio  
Montasjeveiledning  
Montage instructie  
Instruções de montagem  
Instrukcja montażu  
Montageanvisning  
Asennusohjeet  
Montaj talimatı  
Instruțiuni de montaj  
Инструкция по монтажу  
οδηγία συναρμολόγησης  
安装说明书  
تعليمات التركيب



Danger  
Lebensgefahr  
Danger de mort  
Nebezpečí  
Nebezpečenstvo  
Fare  
Peligro  
Életveszély  
Pericolo di morte  
Fare  
Levensgevaar  
Perigo  
Niebezpieczeństwo  
Varning  
Vaara  
Hayati Tehlike  
Pericol  
Опасность  
κίνδυνος θανάτου  
危險  
خطر على الحياة



Installation by electricians only  
Montage nur durch Elektrofachkräfte  
Montage uniquement par un électricien  
Montáž pouze osobami s elektrotechnickou kvalifikací  
Montáž iba osobami s elektrotechnickou kvalifikáciou  
Må kun installeres af en aut. el-installatør  
Debe ser instalado por un profesional eléctrico  
Csak szakképzett személy szerelheti  
Montaggio esclusivamente ad opera di personale specializzato  
Må monteres av autorisert installatør  
Montage alleen door elektromonteurs  
Deve ser instalado por um profissional  
Montaż tylko przez uprawnionych instalatorów  
Får endast utföras av behörig elektriker  
Asennus vain sähköasentajan toimesta  
Sadece uzman kişiler monte edebilir  
Instalare numai de către electricieni  
Монтаж может производить только элекрик  
Εγκατάσταση μόνο από ηλεκτρολόγους  
仅允许合格电气技师进行安装  
التركيب فقط من قبل عمال كهرباء الاختصاصيين

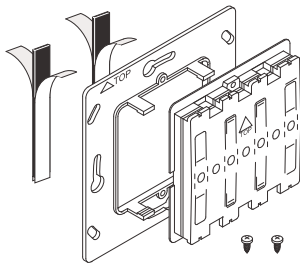

CTAA-01/04  
CTAA-01/04-LED

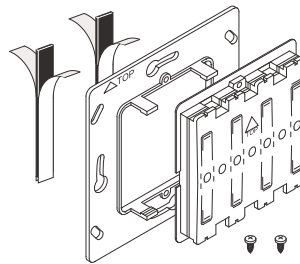

CTAA-02/04  
CTAA-02/04-LED

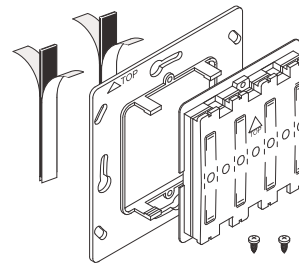

CTAA-04/04  
CTAA-04/04-LED

CWIZ-0X/0X

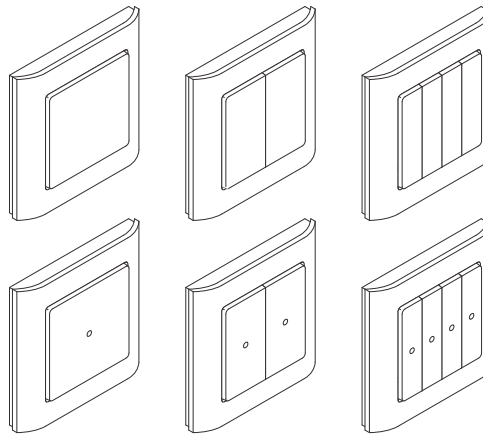
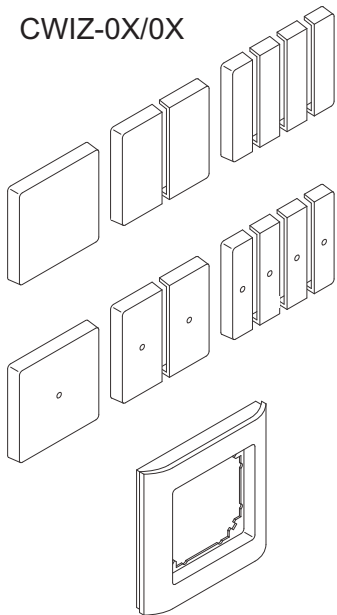

	Min. Version 1.53
	Min. Version 3.5

	T=-25°C - +70°C
	T=+5°C - +40°C

IP20

Merten	Gira	Busch Jaeger	Jung	Berker	Siemens	Elko	Kopp
1-M	Standard 55	Carat*	AS	S.1	Delta line	RS16	Alaska
Atelier M	E2	Pur Edelstahl*	A 500	B.1	Delta vita	Plus	
M-Smart	Event	Solo*	A plus	B.3	Delta miro		
M-Arc	Esprit	Future*	A creation	B.7 Glas	Delta profil**		
M-Star	Profil 55	Future linear*					
M-Plan	E22	CZ Future*					
M-Plan II		Busch-balance® SI					
M-Plan Metall							
M-Plan Glas							

\* only with intermediate frame Busch&Jäger

\*\* only with intermediate frame Siemens

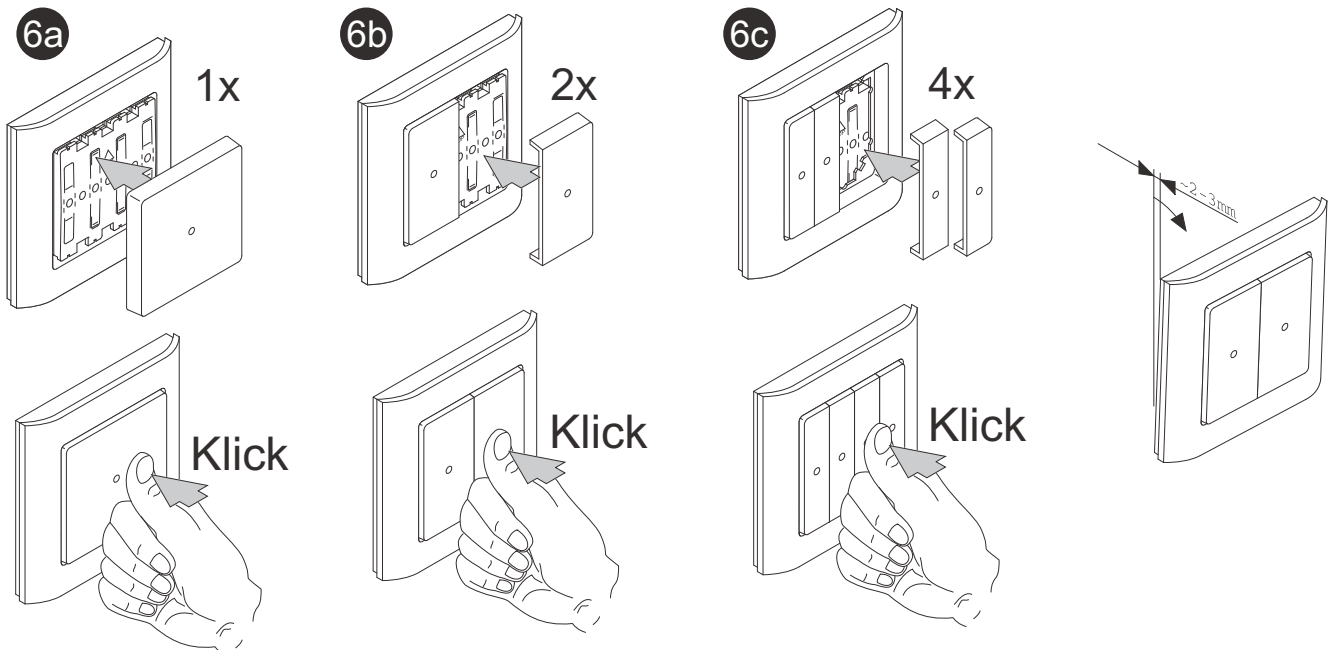
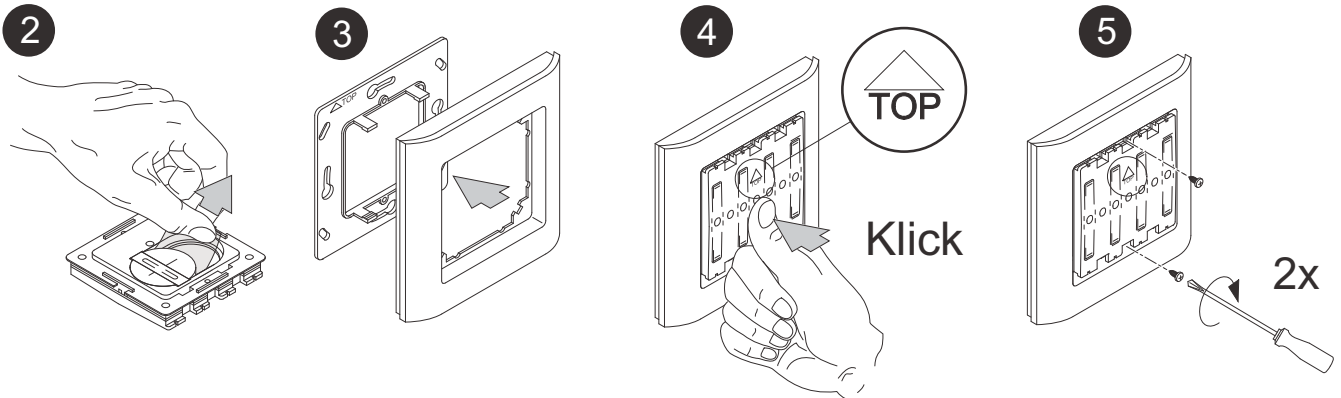
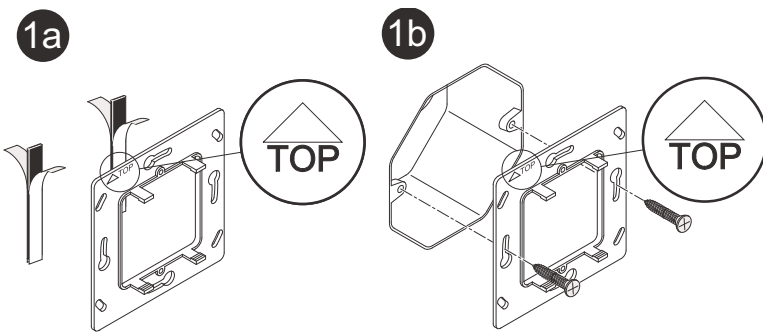
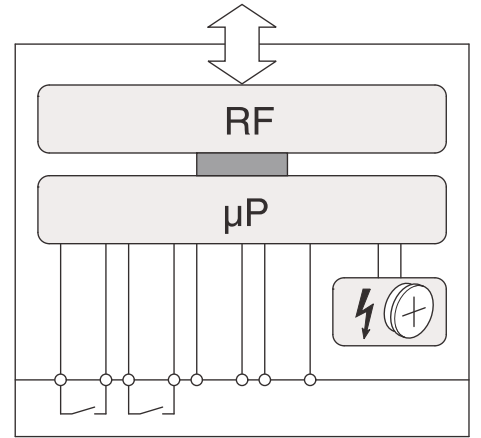
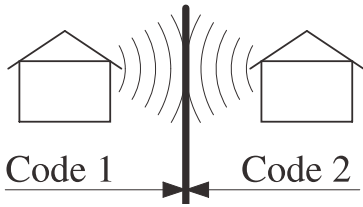
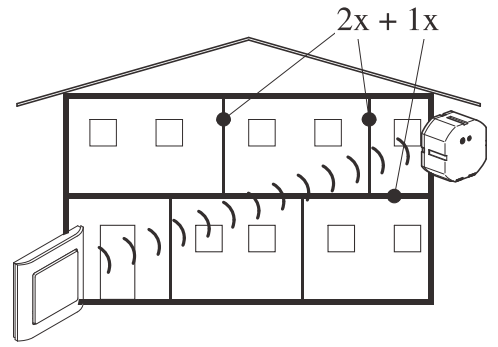
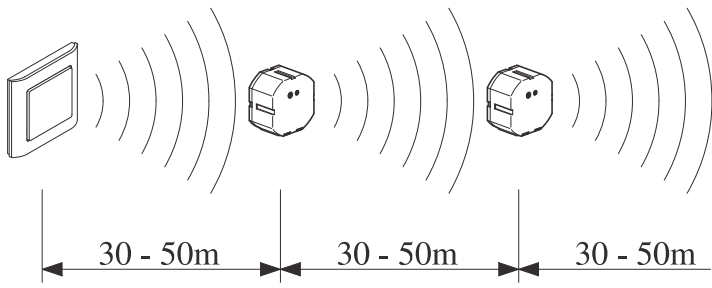

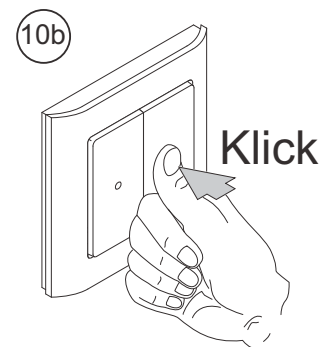
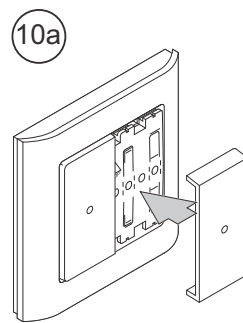
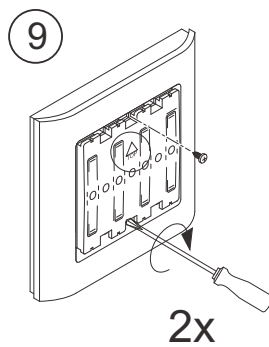
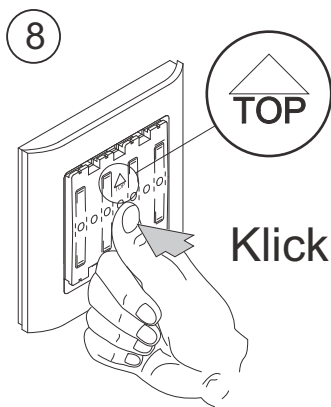
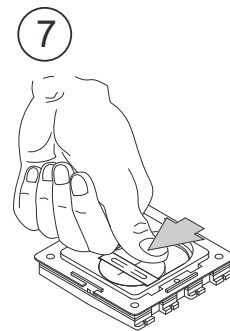
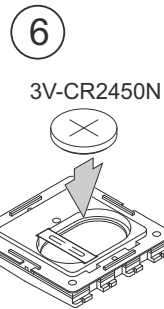
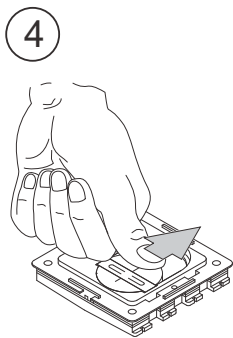
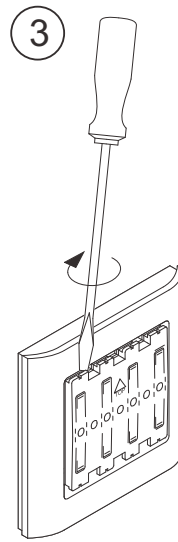
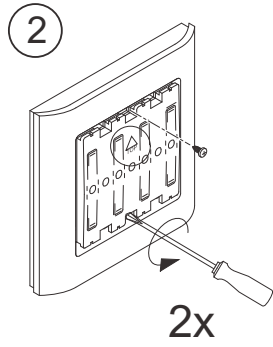
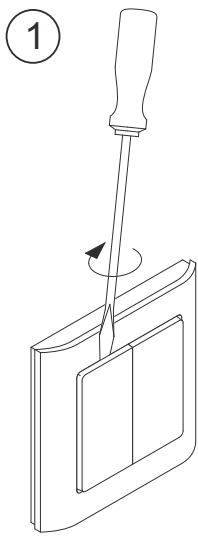

**CTAA-0X/04-LED**

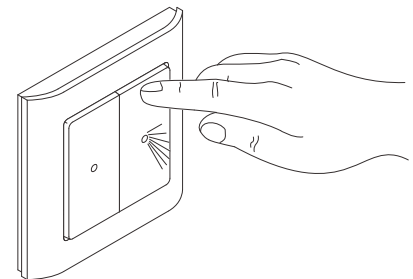
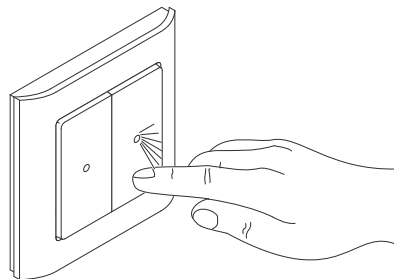

ca. 60-90%	ca. 80-95%	ca. 20-60%	ca. 0-10%	ca. 70-90%	



# Declaration of Conformity

We, EATON Industries (Austria) GmbH  
3943 Schrems, Eugenia 1  
Austria

declare under our sole responsibility that the product (family)

## Eaton - Push Button,

### CTAA-...

(the declaration of conformity applies to all listed types within our actual product catalogue)

provided that it is installed, maintained and used in the application intended for, with respect to the relevant manufacturers instructions, installation standards and "good engineering practices"

complies with the provisions of Council directive(s):

RED Directive 2014/53/EU

RoHS Directive 2011/65/EU

based on compliance with following standard(s):

EN 301489-3 V2.1.1, EN 300220-2 V3.1.1, EN 50491-5-1:2010, EN 50491-5-2:2010, EN 60950-1:2006 + A11:2009 + A1:2010 + A12:2011 + A2:2013, EN 62479:2010, EN 50581:2012



EU- type examination performed by:  
TÜV Austria Services GmbH, Notified Body  
1230 Vienna, Deutschstrasse 10, Austria

Affixing date of CE mark: 2003  
Doc.Id.: CTAA-...171117

Fernando Ceccarelli

Senior Vice President  
General Manager

17.11.2017

Friedrich Schröder

Director Quality  
& Systems

## RF- SYSTEM

### BASIC - MODE - CARD

 CTAA-01/01 CTAA-02/01	 CSAU-01/01	 CJAU-01/01	 CDAU-01/01	 CRCA-00/01	 CHSZ-00/01
------------------------------	----------------	----------------	----------------	----------------	----------------